

Essential Fabric Display – 600 Straight

Assembly Instructions



Overview:

Essential fabric displays feature basic tubular frames coupled with pillowcase fabric graphics. The economy tube frames come with a one year limited warranty. Simply pull the graphic over the frame.

Features and Benefits:

- | | |
|---|---|
| <ul style="list-style-type: none">- Straight aluminum tube frame- Easy to store and ship- Quick to set up- Pillowcase fabric graphic | <ul style="list-style-type: none">- Carry bag included- Bungee cords for easy assembly- One year limited hardware warranty against manufacturer defects |
|---|---|

Hardware Dimensions:







Assembled unit:
26.38" w x 92" h x 17.72" d
670mm(w) x 2337mm(h) x
450mm(d)

Approximate weight with cases:
16 lbs / 7.3 kg

Graphic Material:

Dye-sublimated slip-over
graphics

Items Included:

Hardware					
	6MM HEX KEY x1	LN114-S2-450 x2	LN114-SCRW x2 (already assembled with Bungee Assembly)	ESS-SPREADER-LS-600-S x2	Bungee Assembly x1
	Graphics				
					
	FMLT-ESS-S-600-G x1				

Essential Fabric Display – 600 Straight

Assembly Instructions

Assembly View:

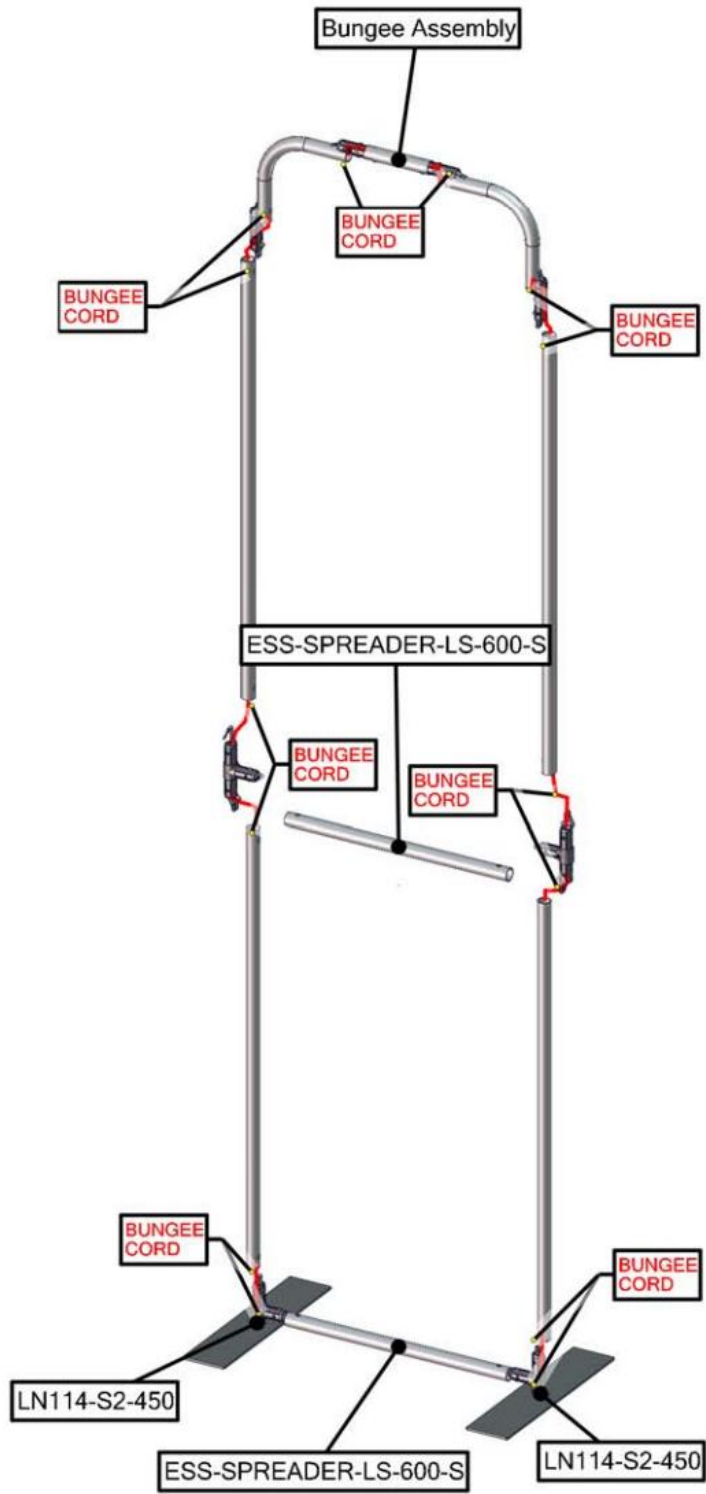
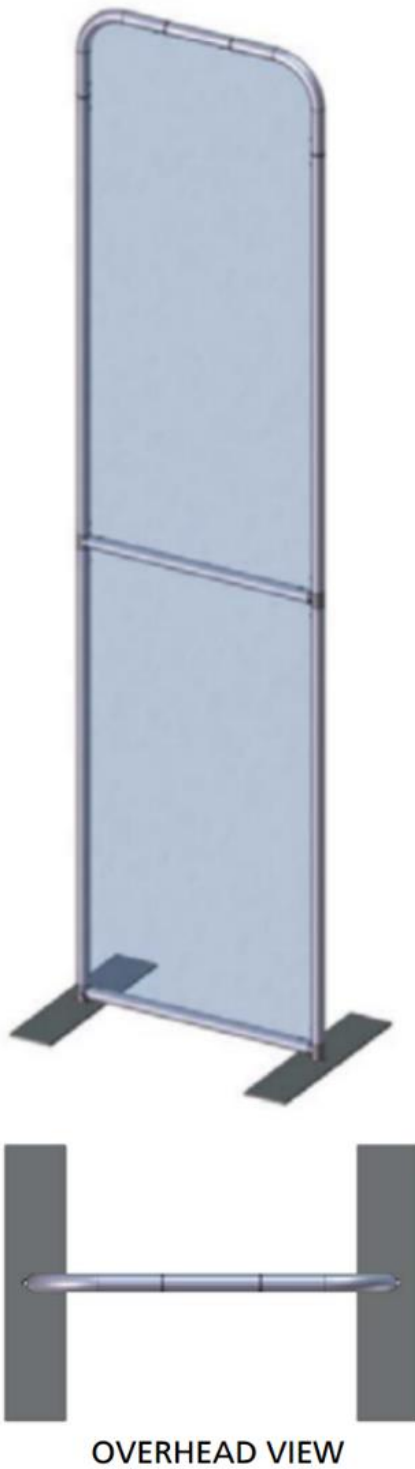

Essential Fabric Display – 600 Straight

Assembly Instructions

Step by Step Instructions:

Step 1.

Assemble the bungee frame.
Attach the long spreaders.

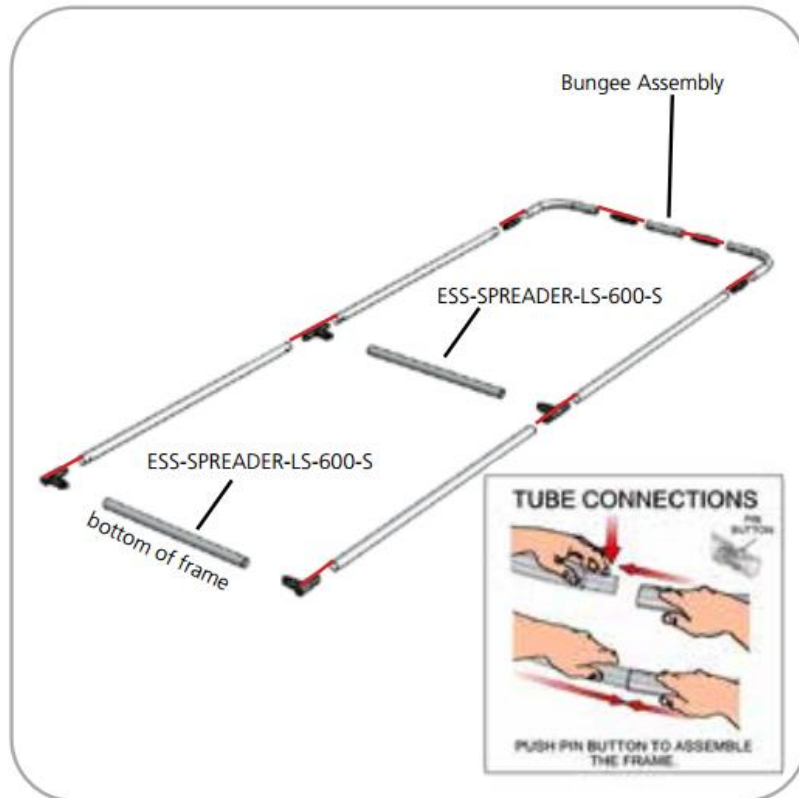

Step 2.

Slip the graphic over the frame.

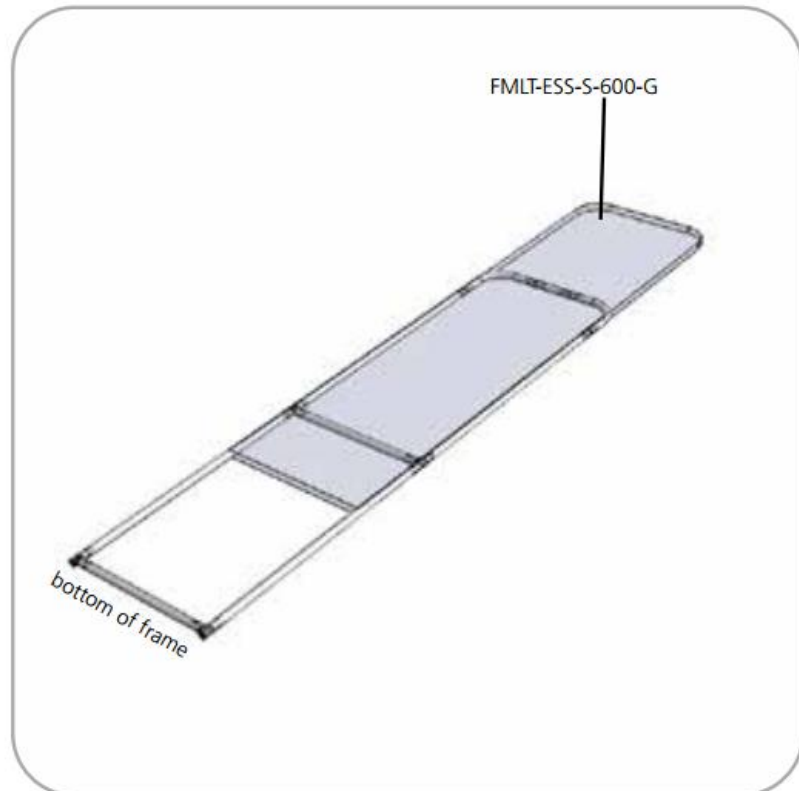

Essential Fabric Display – 600 Straight

Assembly Instructions

Step 3.

Attach the stabilizing bases.

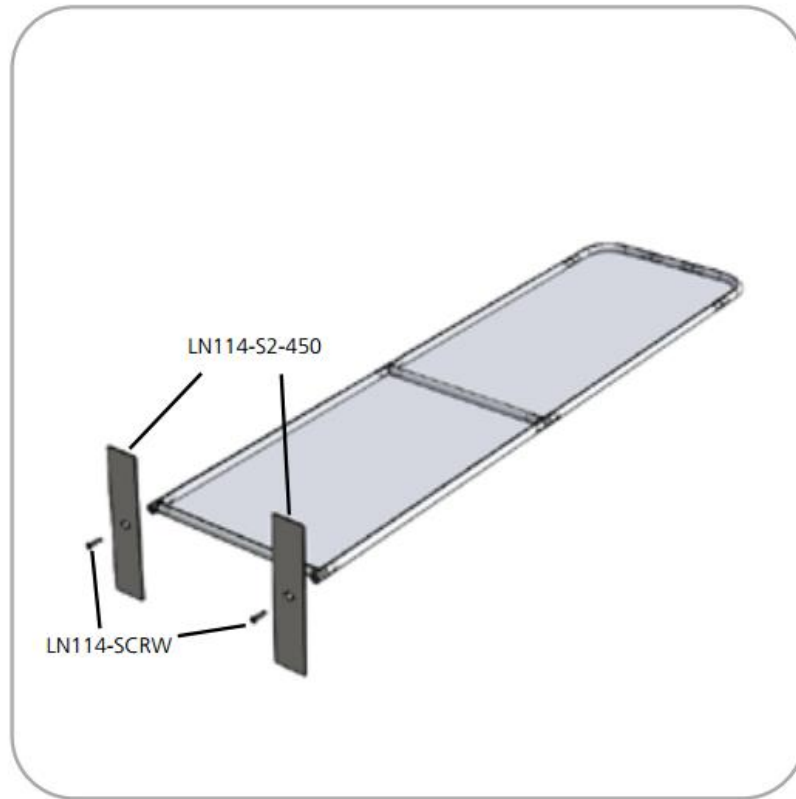

Step 4.

Setup is complete.

